

**SOLE**<sup>™</sup>  
FITNESS

**OWNER'S MANUAL  
E95s Elliptical Trainer**

*Please carefully read this entire manual  
before operating your new elliptical.*

**ATTENTION:** *Before returning your Sole product to any retailer, or if you require any assistance with assembly or technical support please call us first for assistance at 866-780-7653. Thank you for your Sole purchase.*

# TABLE OF CONTENTS

<u>Product Registration</u>	<u>1</u>
<u>Important Safety Instructions</u>	<u>2</u>
<u>Important Electrical Information</u>	<u>3</u>
<u>Important Operation Instructions</u>	<u>4</u>
<u>E95s Assembly Instructions</u>	<u>7</u>
<u>Fitness ELLIPTICAL Features</u>	<u>13</u>
<u>Charging Function</u>	<u>13</u>
<u>Operation of Your New Fitness ELLIPTICAL</u>	<u>14</u>
<u>Bluetooth® Connectivity</u>	<u>16</u>
<u>Using Heart Rate Monitor</u>	<u>25</u>
<u>General Maintenance</u>	<u>26</u>
<u>Manufacturer's Limited Warranty</u>	<u>27</u>



**WARNING:** This product can expose you to chemicals including Toluene and Acrylamide which are known to the State of California to cause Cancer and birth defects or other reproductive harm. For more information, go to [www.P65Warnings.ca.gov](http://www.P65Warnings.ca.gov)

## **ATTENTION**

THIS FITNESS ELLIPTICAL IS INTENDED FOR **RESIDENTIAL USE ONLY** AND IS WARRANTED FOR THE APPLICATION. ANY OTHER APPLICATION **VOIDS** THIS WARRANTY IN ITS ENTIRETY.

**Before returning your Sole product to any retailer, or if you require any assistance with assembly or technical support please call us first for assistance at 866-780-7653. Thank you for your Sole purchase.**

# SOLE

## FITNESS

### CONGRATULATIONS ON YOUR NEW FITNESS ELLIPTICAL AND WELCOME TO THE SOLE FAMILY!

Thank you for your purchase of this quality fitness ELLIPTICAL from **SOLE**. Your new fitness ELLIPTICAL has been manufactured by one of the leading fitness manufacturers in the world and is backed by one of the most comprehensive warranties available. **SOLE** will do all we can to make your ownership experience as pleasant as possible for many years to come.

If there is a question as to where to obtain service, contact our service department at **866-780-7653**.

Please take a moment at this time to record below the name of the dealer, their telephone number, and the date of purchase for easy contact in the future. We appreciate your confidence in **SOLE** and we will always remember that you are the reason that we are in business. Please complete and mail your registration card today and enjoy your new fitness ELLIPTICAL.

Yours in Health,  
**SOLE** Fitness

Nam of Dealer \_\_\_\_\_

Telephone Number of Dealer \_\_\_\_\_

Purchase Date \_\_\_\_\_

## PRODUCT REGISTRATION

### RECORD YOUR SERIAL NUMBER

Please record the Serial Number of this fitness product in the space provided below.

**Serial Number** \_\_\_\_\_

### REGISTER YOUR PURCHASE

The self-addressed product registration card must be completed in full and returned to **SOLE**. You can also go to [www.soletreadmills.com](http://www.soletreadmills.com) under the support tab to register online.

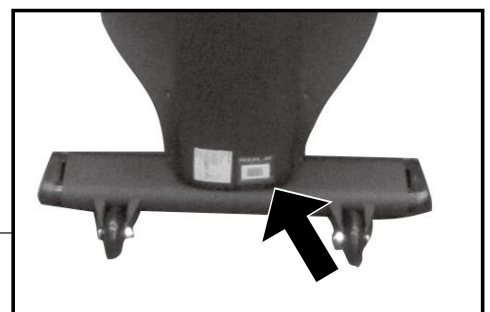

# IMPORTANT SAFETY INSTRUCTIONS

**WARNING-** Read all instructions before using this appliance.

**DANGER-** To reduce the risk of electric shock disconnect your SOLE elliptical from the electrical outlet prior to cleaning and/or service work.

**WARNING-** To reduce the risk of burns, fire, electric shock, or injury to persons, install the elliptical on a flat level surface with access to a 115-volt, 15-amp grounded outlet with only the elliptical plugged into the circuit.

**DO NOT USE AN EXTENSION CORD UNLESS IT IS A 14AWG OR BETTER, WITH ONLY ONE OUTLET ON THE END: DO NOT ATTEMPT TO DISABLE THE GROUNDED PLUG BY USING IMPROPER ADAPTERS, OR IN ANY WAY MODIFY THE CORD SET.**

A serious shock or fire hazard may result along with computer malfunctions. See Grounding Instructions, page 3.

- Do not operate elliptical on deeply padded, plush or shag carpet. Damage to both carpet and elliptical may result.
- K Keep children under the age of 13 away from this machine. There are obvious pinch points and other caution areas that can cause harm.
- Keep hands away from all moving parts.
- Never operate the elliptical if it has a damaged cord or plug. If the elliptical is not working properly, call your dealer.
- Keep the cord away from heated surfaces.
- Do not operate where aerosol spray products are being used or where oxygen is being administered. Sparks from the motor may ignite a highly gaseous environment.
- Never drop or insert any object into any openings.
- Do not use outdoors.
- To disconnect, turn all controls to the off position and then remove the plug from the outlet.
- Do not attempt to use your elliptical for any purpose other than for the purpose it is intended.
- The hand pulse sensors are not medical devices. Various factors, including the user's movement, may affect the accuracy of heart rate readings. The pulse sensors are intended only as exercise aids in determining heart rate trends in general.
- Wear proper shoes. High heels, dress shoes, sandals or bare feet are not suitable for use on your elliptical. Quality athletic shoes are recommended to avoid leg fatigue.
- This appliance is not intended for use by persons with reduced physical, sensory or mental capabilities, or lack of experience and knowledge, unless they have been given supervision or instruction concerning use of the appliance by a person responsible for their safety.

**SAVE THESE INSTRUCTIONS - THINK SAFETY!**

# IMPORTANT ELECTRICAL INSTRUCTIONS

## **WARNING!**

**NEVER** remove any cover without first disconnecting AC power.

If voltage varies by ten percent (10%) or more, the performance of your fitness ELLIPTICAL may be affected. **Such conditions are not covered under your warranty.** If you suspect the voltage is low, contact your local power company or a licensed electrician for proper testing.

**NEVER** expose this fitness ELLIPTICAL to rain or moisture. This product is **NOT** designed for use outdoors, near a pool or spa, or in any other high humidity environment. The operating temperature specification is 40 to 120 degrees Fahrenheit, and humidity is 95% non-condensing (no water drops forming on surfaces).

## GROUNDING INSTRUCTIONS

**This product must be grounded.** If the elliptical should malfunction or breakdown, grounding provides a path of least resistance for electric current, reducing the risk of electric shock.

This product is equipped with a cord having an equipment-grounding plug. The plug must be plugged into an appropriate outlet that is properly installed and grounded in accordance with all local codes and ordinances.

**DANGER - Improper connection of the equipment-grounding conductor can result in a risk of electric shock. Check with a qualified electrician or serviceman if you are in doubt as to whether the product is properly grounded. Do not modify the plug provided with the product if it will not fit the outlet; have a proper outlet installed by a qualified electrician.**

This product is for use on a nominal 115-volt circuit, and has a grounding plug that looks like the plug illustrated below. A temporary adapter that looks like the adapter illustrated below may be used to connect this plug to a 2-pole receptacle as shown below if a properly grounded outlet is not available. The temporary adapter should be used only until a properly grounded outlet, (shown below) can be installed by a qualified electrician. The green colored rigid ear-lug, or the like, extending from the adapter, must be connected to a permanent ground such as a properly grounded outlet box cover. Whenever the adapter is used, it must be held in place by a metal screw.

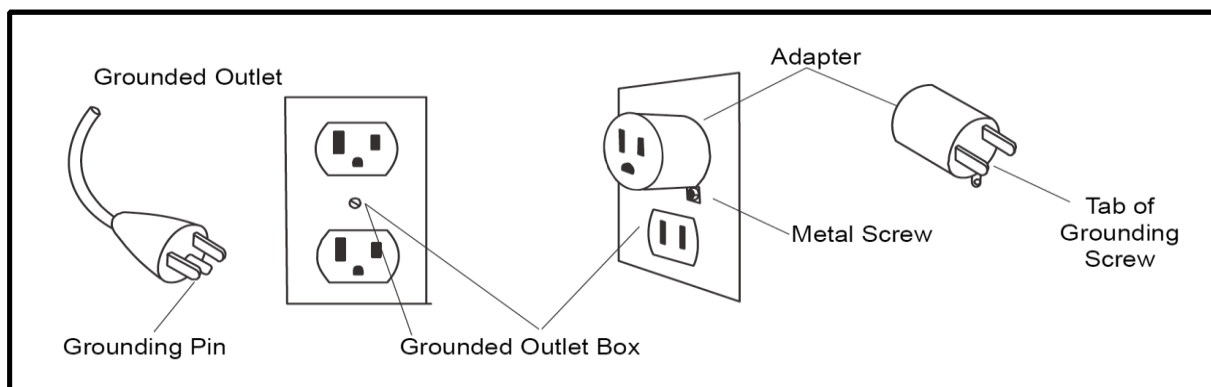

# IMPORTANT OPERATION INSTRUCTIONS

- **NEVER** operate this elliptical without reading and completely understanding the results of any operational change you request from the computer.
- Understand that changes in resistance and stride do not occur immediately. Set your desired resistance level on the computer console and release the adjustment key. The computer will obey the command gradually.
- **NEVER** use your elliptical during an electrical storm. Surges may occur in your household power supply that could damage elliptical components. Unplug the elliptical during an electrical storm as a precaution.
- Use caution while participating in other activities while using your elliptical; such as watching television, reading, etc. These distractions may cause you to lose balance; which may result in serious injury.
- Always hold on to a handle bar while making control changes (stride, level, etc.).
- Do not use excessive pressure on console control keys. They are precision set to function properly with little finger pressure. If you feel the buttons are not functioning properly with normal pressure contact your SOLE dealer.

# E95s ASSEMBLY PACK CHECKLIST

## 1 HARDWARE STEP 1

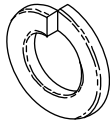

**#186.** 3/8" x 2T Split Washer (4 pcs)

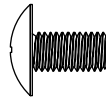

**#150.** M5 x 10m/m Phillips Head Screw (6pcs)

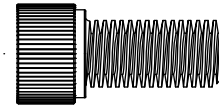

**#145.** 3/8" X 3/4" Socket Head Cap Bolt (4 pcs)

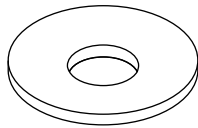

**#176.** 3/8" x 19 x 1.5T Flat Washer (6 pcs)

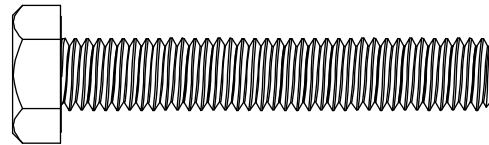

**#137.** 3/8" x 2-1/4" Hex Head Bolt (2 pcs)

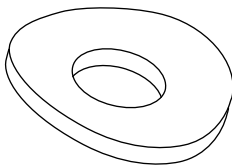

**#187.** 3/8" x 23 x 2T Curved Washer (4 pcs)

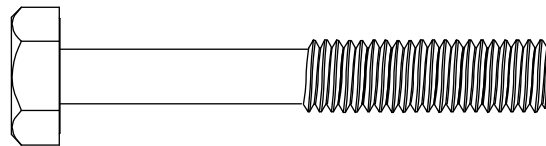

**#139.** 3/8" x 3-3/4" Hex Head Bolt (4 pcs)

## 2 HARDWARE STEP

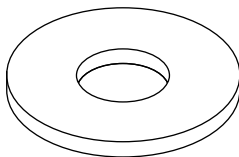

**#175.** 3/8" x 30 x 2T Flat Washer (2 pcs)

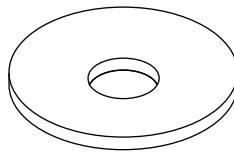

**#180.** 5/16" x 20 x 1.5T Flat Washer (2 pcs)

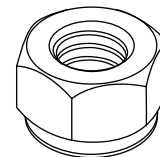

**#168.** 5/16" x 9T Nyloc Nut (2 pcs)



**#204.** Ø25 Wave Washer (2 pcs)

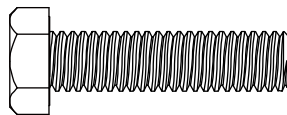

**#134.** 5/16" x 1-1/4" Hex Head Bolt (2 pcs)

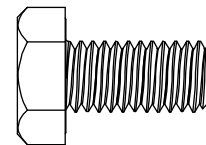

**#136.** 3/8" x 3/4" Hex Head Bolt (2 pcs)

# 3 HARDWARE STEP 3

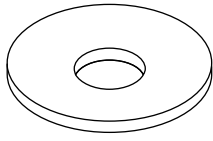

**#176.** 3/8" x 19 x 1.5T  
Flat Washer (8 pcs)

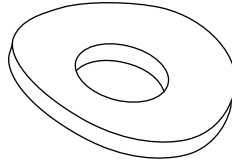

**#187.** 3/8" x 23 x 2T  
Curved Washer (4 pcs)



**#97.** Switch Wire Cap  
(2 pcs)

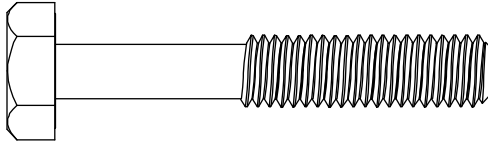

**#138.** 3/8" x 2-1/4"  
Hex Head Bolt (6 pcs)

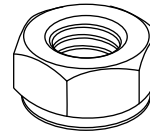

**#165.** 3/8" x 7T  
Nyloc Nut (6 pcs)

# 4 HARDWARE STEP 4



**#152.** M5 x 15mm  
Phillips Head Screw  
(14 pcs)

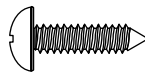

**#153.** 3.5mm x 12mm  
Sheet Metal Screw  
(12 pcs)

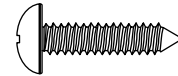

**#154.** 4mm x 15mm  
Sheet Metal Screw  
(2 pcs)

# ASSEMBLY TOOLS

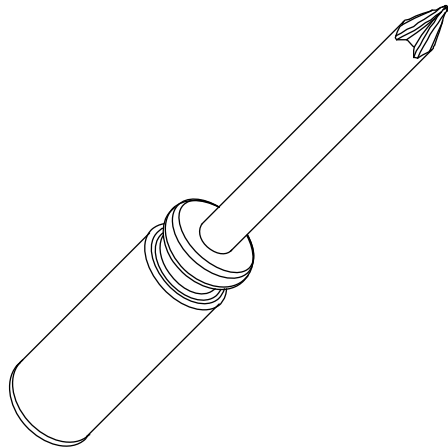

**#192.** Phillips Head Screw Driver

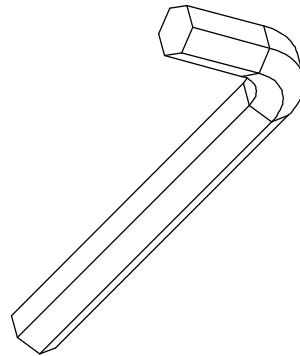

**#193.** M8\_L Allen Wrench

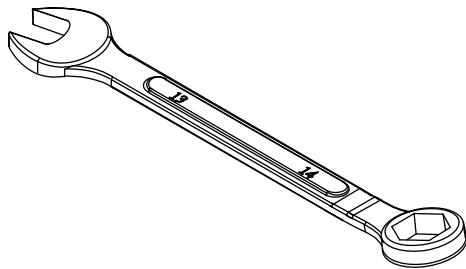

**#194.** 13/14m/m\_Wrench

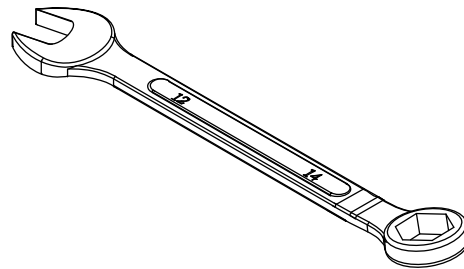

**#195.** 12/14m/m\_Wrench

## E95s ASSEMBLY INSTRUCTIONS

### PRE-ASSEMBLY

1. Using a razor knife (Box Cutter) cut the outside, bottom, edge of box along the dotted Line. Lift Box over the unit and unpack.
2. Carefully remove all parts from carton and inspect for any damage or missing parts. If damaged parts are found, or parts are missing, contact your dealer immediately.
3. Locate the hardware package. Remove the tools first. Remove the hardware for each step as needed to avoid confusion. The numbers in the instructions that are in parenthesis (#) are the item number from the assembly drawing for reference.

# REMOVE SHIPPING STABILIZER

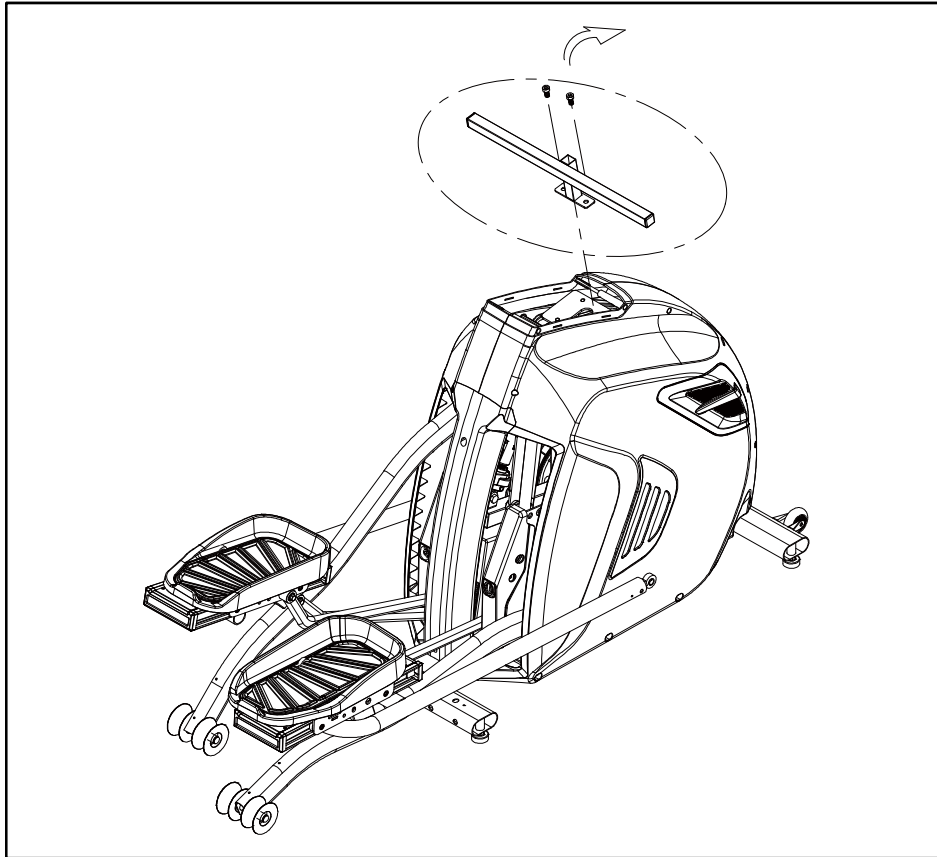

1. Use the Allen Wrench (**193**) to remove the two Bolts and discard the shipping stabilizer.

# 1 REAR RAILS/CONSOLE MAST

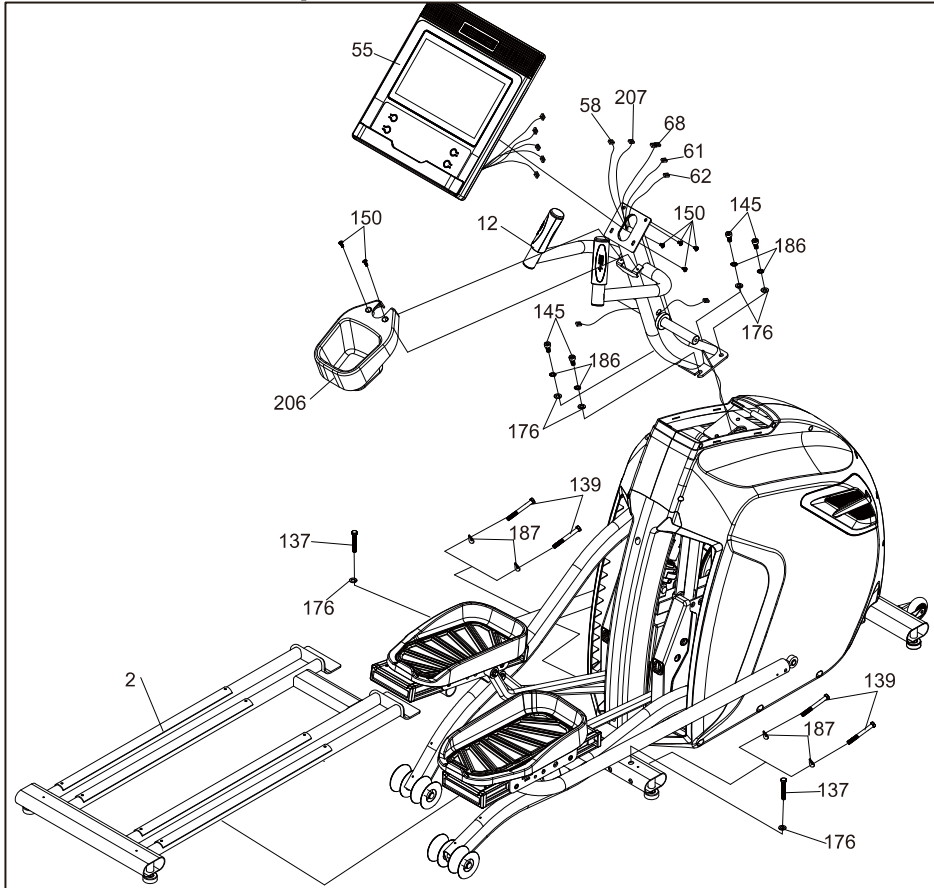

## HARDWARE STEP 1

- 186.** 3/8" x 2T Split Washer (4 pcs)
- #150.** M5 x 10mm Phillips Head Screw (6pcs)
- #145.** 3/8"X3/4" Socket Head Cap Bolt (4 pcs)
- #176.** 3/8"x19 x1.5T Flat Washer (6 pcs)
- #137.** 3/8" x 2-1/4" Hex Head Bolt (2 pcs)
- #187.** 3/8"x23x2T Curved Washer (4 pcs)
- #139.** 3/8" x 3-3/4" Hex Head Bolt (4 pcs)

1. Put the 2pcs Flat Washers (**176**) on the 2pcs Hex Head Bolts (**137**) and hand-tighten them, through the Top of the Rear Stabilizer Tube (Main Frame), into the Rear Rail Assembly (**2**) by using the Wrench (**194**).  
 (2) Put the 4pcs of Curved Washers (**187**) on the 4pcs Hex Head Bolts (**139**) and hand-tighten them through the Front of the Rear Stabilizer Tube (Main Frame), into the Rear Rail Assembly (**2**) by using Wrench (**194**).
2. Use L Allen Wrench (**193**) to release 2pcs Socket Head Cap Bolts (**145**) and take apart side back disposed. Pierce Computer Cable (**68**) from bottom of the mast tube through it and pull out of the top. Use 4pcs Socket Head Cap Bolts (**145**), 4pcs Spring Washers (**186**) and 4pcs Flat Washers (**176**) to secure.
3. Install the Bottle Holder (**206**) to the Console Mast (**12**) with 2pcs Phillips Head Screws (**150**) and tighten with the provided Phillips Head Screw Driver (**192**).  
 ※Please note the bottle holder must be assembled before console assembly.
4. Untie the Computer Cable (**68**), connect two Handpulse W/Cable Assembly (**58 & 207**) and Handle Wire (Upper), Resistance/ Incline(**61,62**) with the Console Assembly (**55**) respectively. Then place the Console on top of the Mast and use Phillips Head Screw Driver (**192**) to tighten 4pcs Phillips Head Screws (**150**) to secure.

# 2 LOWER SWING ARMS

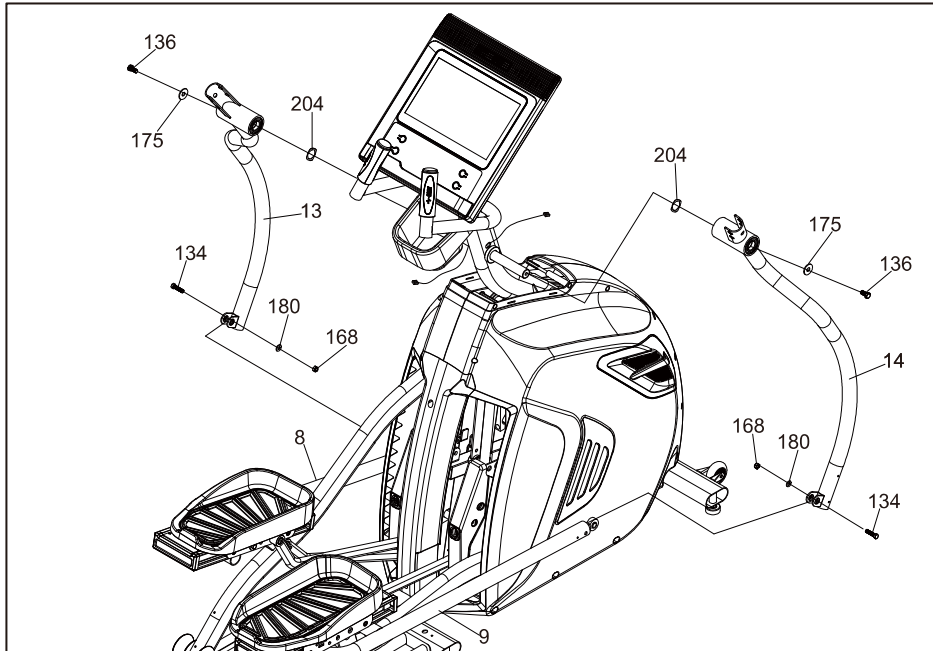

## HARDWARE STEP 2

- #175. 3/8" x 30 x 2T Flat Washer (2 pcs)
- #180. 5/16" x 20 x 1.5T Flat Washer (2 pcs)
- #168. 5/16" x9T Nyloc Nut (2 pcs)
- #204.  $\phi$ 25 Wave Washer (2 pcs)
- #134. 5/16" x 1-1/4" Hex Head Bolt (2 pcs)
- #136. 3/8" x 3/4" Hex Head Bolt (2 pcs)

1. Locate left and right Lower Handle Bars (**13**, **14**) together with 2pcs Wave Washers(**204**) onto left and right shafts of the mast tube then tighten with 2pcs Hex Head Bolts (**136**) and 2pcs Flat Washers (**175**) by using Wrench (**194**).
2. Untie Rod end Bearing on left Connecting Arm (**8**) and pierce Hex Head Bolt (**134**) through the rod end holes and rod end bearing then tighten with Flat Washer (**180**) and Nylon Nut (**168**) by using Wrench (**194**) and Wrench (**195**). Do it the same way for right Connecting Arm (**9**) and right Lower Handle Bar (**14**).

# 3 SWING ARMS

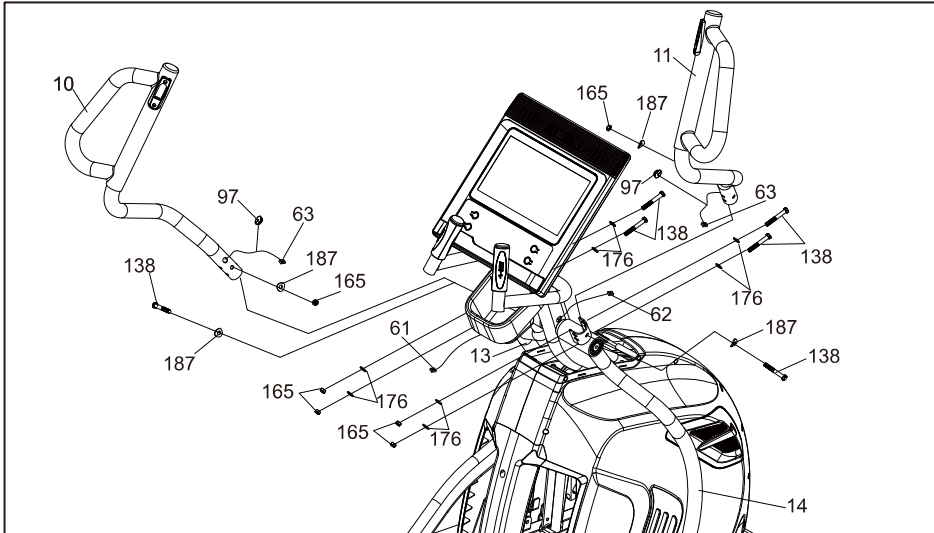

## HARDWARE STEP 3

- #176. 3/8"x19x1.5T Flat Washer (8 pcs)
- #187. 3/8"x23x2T Curved Washer (4 pcs)
- #97. Switch Wire Cap (2 pcs)
- #138. 3/8" x 2-1/4" Hex Head Bolt (6 pcs)
- #165. 3/8" x7T Nyloc Nut (6 pcs)

1. Insert left Swing Arm (10) onto left Lower Handle Bar (13) and secure with 3pcs Hex Head Bolts (138), 4pcs Flat Washers (176), 2pcs Curved Washers (187) and 3pcs Nylon Nuts(165) by using Wrench (194) and Wrench (195). Do it the same way for right Swing Arm (11) and right Lower Handle Bar (14).
2. Connect Handle Wire (Upper), Resistance(61) and Handle Wire (Upper), Incline(62) to two Handle Wires (Lower), Resistance/Incline (63) respectively and save the excessive wires in the mast tube. Finally, plug in Switch Wire Caps (97) onto the mast tube to secure the wire.

# 4 PLASTIC COVERS

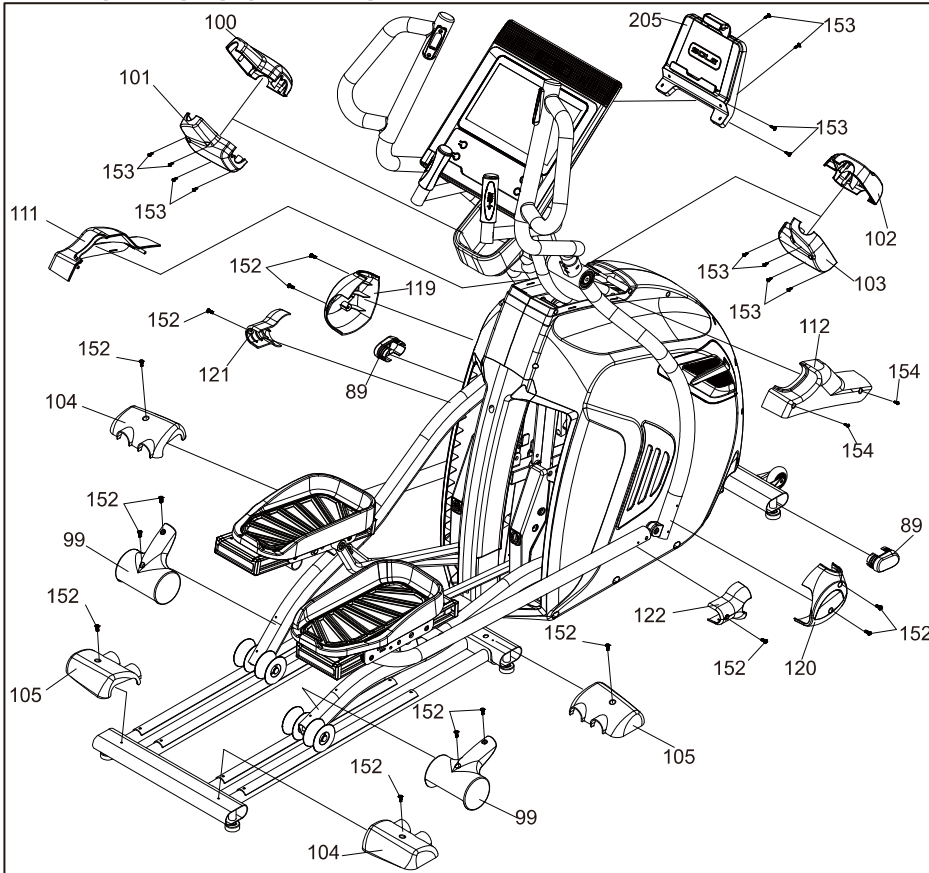

## HARDWARE STEP 4

#152. M5 × 15mm  
Phillips Head Screw  
(14 pcs)

#153. 3.5mm × 12mm  
Sheet Metal Screw  
(12pcs)

#154. 4mm × 15mm  
Sheet Metal Screw  
(2pcs)

1. Secure left Connecting Arm Cover B (121) on left Connecting Arm with Phillips Head Screw (152) by using Phillips Head Screw Driver (192) then secure left Connecting Arm Cover A (119) with 2pcs Phillips Head Screws (152) on Lower Handle Bar. Do it the same way for right Connecting Arm Cover B (122) and right Connecting Arm Cover A (120) on right Connecting Arm and right Lower Handle Bar, respectively.
2. Secure two Slide Wheel Covers (99) on both left and right Pedal arms with 4pcs Phillips Head Screws (152) by using Phillips Head Screw Driver (192).
3. Use Phillips Head Screw Driver (192) with 4pcs Phillips Head Screws (152) Secure two Rear Stabilizer Covers (A) (104) and two Rear Stabilizer Cover (B) (105) on both left and right sides of rear tube of rear rail assembly.
4. Match left and right Console Mast Covers (111, 112) with left and right side cases respectively and secure with 2pcs Sheet Metal Screws (154) by using Phillips Head Screw Driver (192).
5. Match Front Handle Bar Cover (100) and Rear Handle Bar Cover (101) with each other on left Lower Handle Bar and use Phillips Head Screw Driver to tighten 4pcs Sheet Metal Screws (153). Do the same for right Front Handle Bar Covers (102) and Rear Handle Bar Cover (103). (Be aware not to pinch the wire)
6. Plug in both Oval End Caps (89) onto both ends of the front stabilizer tube.
7. Install the Tablet Holder (205) to back of the console with 4pcs Sheet Metal Screws (153).

# FITNESS ELLIPTICAL FEATURES

## STRIDE LENGTH ADJUSTMENT

The E95s has unique adjustable stride length feature that will further increase the variety of your workouts. When the stride setting is at its lowest position the stride length will be 18 inches. This setting is used when pedaling slowly or during quick bursts at very high resistance. The top setting is 24 inches and is used during higher speed pedaling. The stride adjustment can also be used to select a stride length that is comfortable for you.

The stride length can also be computer controlled. The stride length can be controlled by buttons on the console or left swing arm and also can be automatically adjusted during the built-in workout programs.

## Wireless Charging

Wireless Charging function:

Charge your personal device during your workout by placing it inside the wireless charging box/area properly.

NOTE :

\*\* Your device must be set in the landscape orientation for best result.

\*\* Your device "charging" icon will indicate it is charging.

\*\*\* It provides up to 10 watts of power for many cell phones supporting wireless charging function.



# OPERATION OF YOUR FITNESS ELLIPTICAL

## GETTING FAMILIAR WITH THE CONTROL PANEL

### E95s CONSOLE

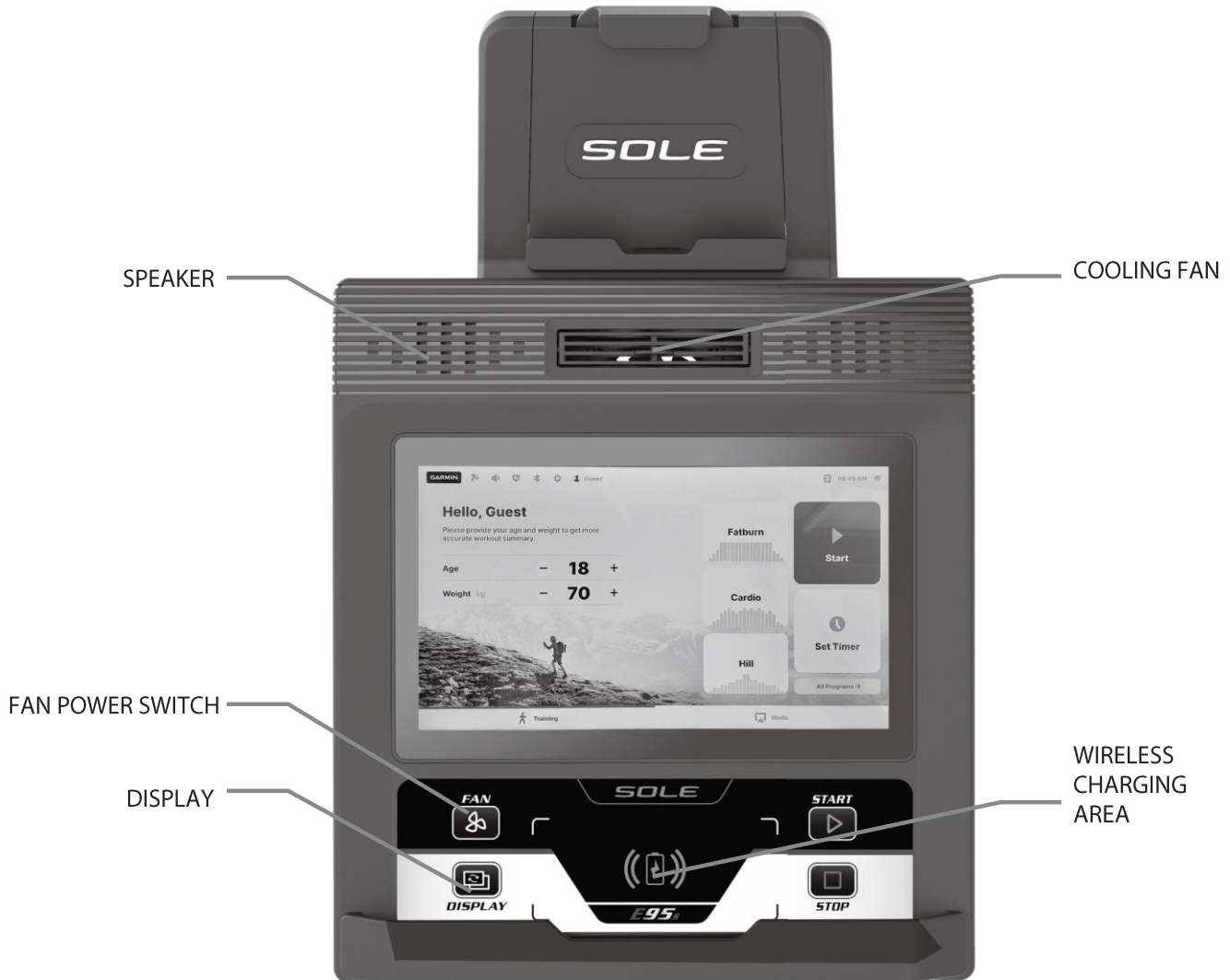

#### POWER UP

When power is connected to the elliptical, the console will automatically power up. This model is connected directly to 115 VAC and there is a power switch located where the line cord plugs into the unit on the left side near the front.

#### \*\*ATTENTION\*\*

**SLEEP MODE** Your console comes in "Sleep mode" with different features by choice:

**ON** The unit goes energy-saving state after 15 minutes of inactivity.

**OFF** The console will stay lit while the power is on.

**RETAIL** The console will run the demo video after 3 minutes of inactivity.

**On TFT** displays, click "Sleep Mode" under Settings to switch among three features.

# CONSOLE OPERATION

## BASIC INFORMATION

The Elliptical has a built in heart rate monitoring system. Simply grasp the **Contact Heart Rate Sensors** on the stationary handle bars or wear the chest strap transmitter. This may take a few seconds. The **PulseWindow** will display your heart rate in beats per minute. The chest strap is a more accurate and reliable method of heart rate reading. The hand pulse sensors are subject to false readings depending on user physiology and workout habits including how one grips the sensors or how sweaty their hands are.

A message about Calories: Calorie readings on every piece of exercise equipment, whether it is in a gym or at home, are not accurate and tend to vary widely. They are meant only as a guide to monitor your progress from workout to workout. The only way to accurately measure your calorie burn is in a clinical setting connected to a host of machines. This is because every person is different and burns calories at a different rate.

## STOP KEY

The **Stop** button actually has several functions.

Pressing the **Stop** key once during a program will **Pause** the program. If you need to get a drink, answer the phone or any of the many things that could interrupt your workout, this is a great feature. To resume your workout during **Pause**, just press the **Start** key. If the **Stop** button is pressed twice during a workout the program will end and a **Workout Summary** will be displayed.

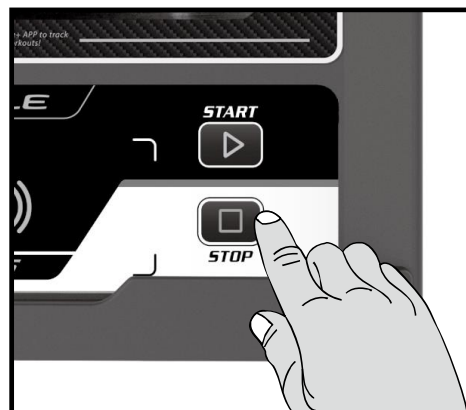

## New SOLE + App to be used in conjunction with select Apple & Android devices!

In order to help you achieve your exercise goals, Sole has added an exciting new feature to this product. Your new exercise machine comes equipped with a Bluetooth® transceiver that will allow it to interact with compatible iOS and Android smartphones or tablet computers via the SOLE+ App.

Just download the free SOLE+ App from the Apple Store or Google Play, and follow the instructions in the App to sync with your exercise machine.

The Sole+ App also allows you to sync your workout data with one of many fitness cloud sites we support: Apple Health, Google Fit, Strava, MapMyFitness or Fitbit, with more to come.

Syncing the App with your exercise machine:

After downloading the App, make sure Bluetooth® is enabled on your device, then tap the icon at the top right corner to search for Sole equipment.

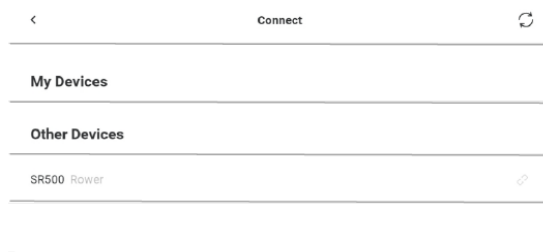
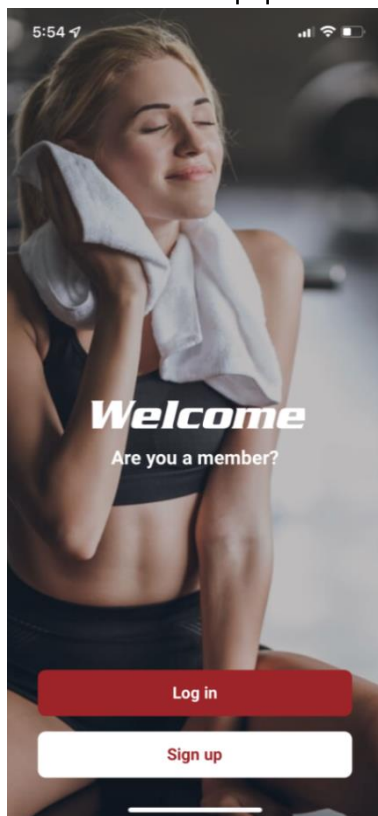

After the equipment is detected, tap Connect. When the App and equipment are synced, Bluetooth® icon on the equipment's console will light up. You may now start using your new Sole product!

Exercise equipment's Bluetooth device can also be connected to Bluetooth wireless heart rate chest strap transmitter. Chest Strap transmitter can still connect the exercise equipment even though the App has already been connected with the exercise equipment.

The exercise equipment can also play music wirelessly via Bluetooth. Turn on your mobile phone or tablet's Bluetooth function. Search for the name "Bt-speaker" in your device's Bluetooth menu. Tap to connect. Now your device can transmit music to the exercise equipment.

# Touchscreen Operation

Use the touchscreen console to select from a variety of preset workout programs and fitness tests, and to enjoy media content of your choice while on the go.

The User Interface (UI) images in the manual reflect the version of software when the product was produced. The software version may be updated occasionally to include new features or repair any bugs when connected to the internet. These updates may change the UI images on the console and may no longer match the manual images.

## Getting Started

Launched for the first time, the console will prompt you to either enter as a guest, or create a new profile. It is recommended to set up your own profile: it allows your machine to remember your physical parameters, favorite programs and templates; you will have your own custom program with an adjustable intensity pattern, and your workout records can be synchronized with the SOLE+ mobile app. Tap + to create a new profile. A maximum of 9 profiles can be created. Each profile can be protected with a passcode.

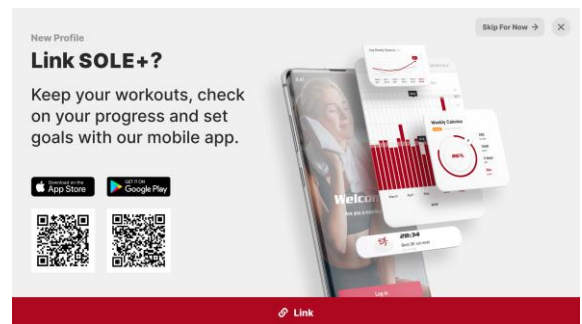
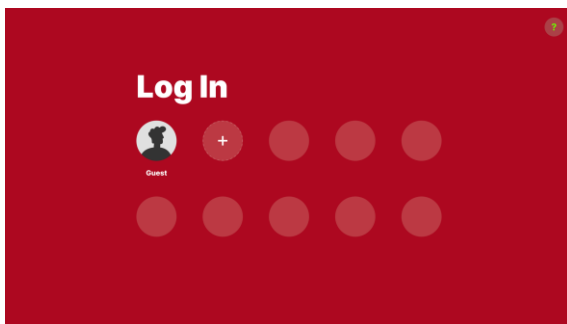

To link a SOLE+ account, scan the QR code on the console screen to download the mobile app first. Once the app is installed and the registration is complete, press “Link” on the bottom of the console screen, then open the QR code scanning camera in your SOLE+ app, and scan the QR code once again to link your local profile with the SOLE+ account. Please keep in mind that your console profile cannot be linked to multiple SOLE+ accounts at the same time. If you skip this step, you can access it again later in Profile settings.

## Home Screen

**The main screen** of the Training section displays an overview of your activity, and offers shortcuts to the most frequently used training modes: an immediate Start, a manually controlled timed workout (“Timer”), and up to 6 programs that you have marked as your favorites are arranged on this page for your quick access.

If in the Guest mode, you can set your age and weight here; it will help the machine calculate your workout summary more accurately.

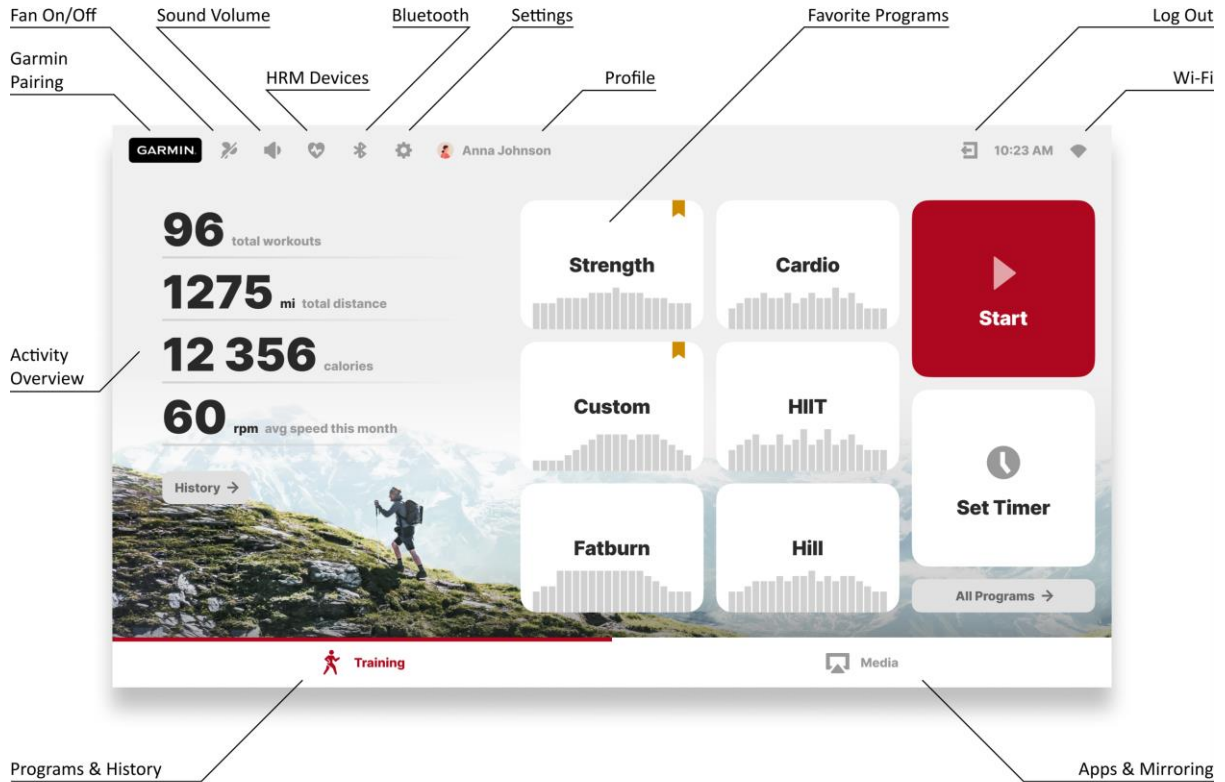

## Workout Programs

To access all available categories of programs, press “All Programs” on the Home screen. Once inside, you can use tabs on the top of the screen to switch between All Programs, Templates and Favorites.

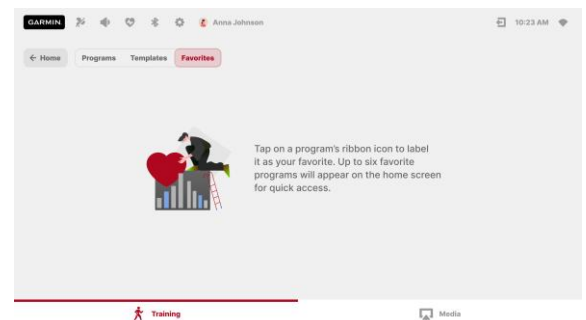
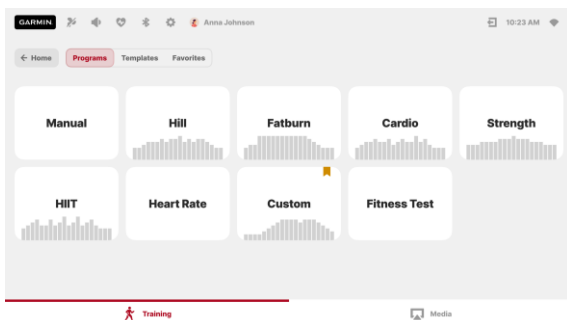

Tap on any of the program cards to open a Program Setup page, where you can learn more about the program, set properties of your workout, or keep browsing by pressing on the arrow buttons in the upper top right corner of the screen. To adjust workout parameters, you can drag the ruler, tap on the + and – buttons, or tap on the number to open a numpad and input the value directly.

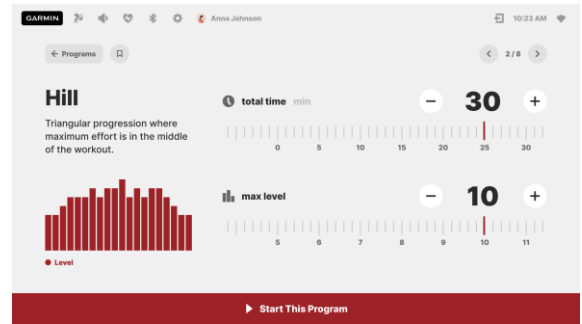
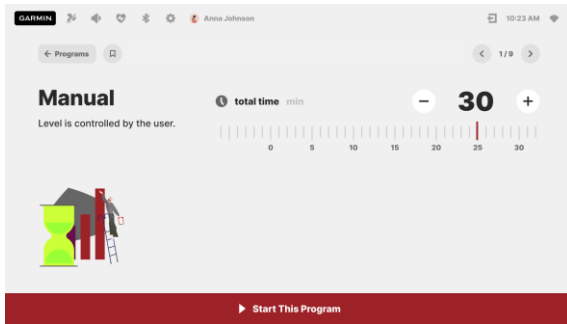

**Manual (Timer)** program is a timed workout with resistance level controlled manually at any time during the workout.

**Hill, Fatburn, Cardio, Strength** and **HIIT** follow preset level and stride changing patterns. The Total Time and Max Level settings define the duration and overall intensity of your workout.

The built-in level of difficulty for each segment is shown in the chart below. However, if you change the maximum level on the program setup page before start, all segments throughout the program will be adjusted proportionally.

Program	SEG	1	2	3	4	5	6	7	8	9	10	11	12	13	14	15	16	17	18	19	20
Hill	Level	1	2	2	3	3	4	4	5	5	7	7	5	5	4	4	3	3	3	2	1
	Stride	18.0	18.0	18.0	18.0	18.0	18.0	18.0	18.0	18.0	18.0	18.0	18.0	18.0	18.0	18.0	18.0	18.0	18.0	18.0	18.0
Fatburn	Level	1	2	3	5	5	5	5	5	5	5	5	5	5	5	5	5	5	3	2	1
	Stride	18.0	18.0	18.0	18.0	18.0	18.0	18.0	18.0	18.0	18.0	18.0	18.0	18.0	18.0	18.0	18.0	18.0	18.0	18.0	18.0
Cardio	Level	1	2	3	5	6	7	6	6	6	7	6	5	6	7	6	5	6	5	2	1
	Stride	18.0	18.0	18.0	18.0	18.0	18.0	18.0	18.0	18.0	18.0	18.0	18.0	18.0	18.0	18.0	18.0	18.0	18.0	18.0	18.0
Strength	Level	1	2	2	3	3	4	4	5	5	6	7	7	8	8	8	8	8	6	4	1
	Stride	18.0	18.0	18.0	18.0	18.0	18.0	18.0	18.0	18.0	18.0	18.0	18.0	18.0	18.0	18.0	18.0	18.0	18.0	18.0	18.0
HIIT	Level	1	2	2	7	7	2	2	7	7	2	2	7	7	2	2	7	7	2	2	1
	Stride	18.0	18.0	18.0	18.0	18.0	18.0	18.0	18.0	18.0	18.0	18.0	18.0	18.0	18.0	18.0	18.0	18.0	18.0	18.0	18.0

**Heart Rate** program uses resistance to control your heart rate. The resistance level gradually increases until you reach your target heart rate, then adjusts automatically to keep you within 5 bpm of your goal. A heart rate monitor is required for this program.

On the program setup page, you can either set the target bpm directly or select 60% or 80% of your age-predicted maximum heart rate, allowing the machine to calculate your target automatically. Choosing the second option, make sure you have let the machine know how old you are, otherwise the calculations will be based on the default values. The program is finished when the time is up, or if your heart rate is 20% higher than the target.

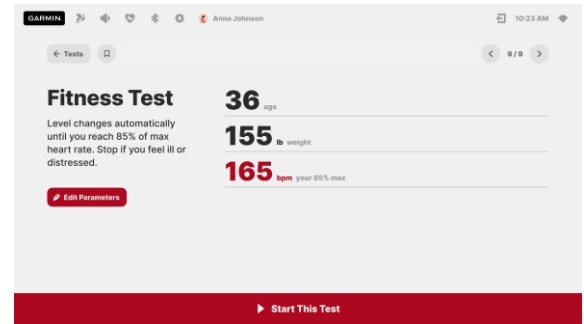
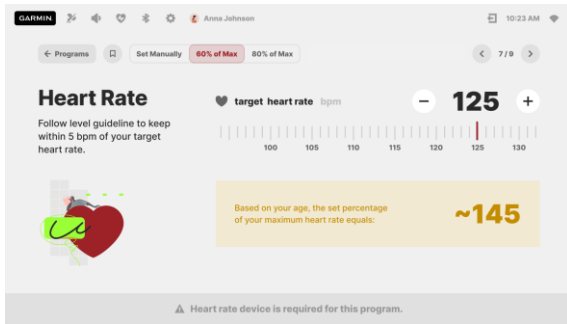

The **Fitness Test** is based on the YMCA Protocol and is a sub-maximal test that uses pre-determined, fixed work levels that are based on your heart rate readings as the test progresses. The test will take anywhere between 6 and 15 minutes to complete, depending on your level of fitness. The test ends when your heart rate reaches 85% of maximum at any time during the test, or if your heart rate is between 110 bpm and 85% at the end of the two consecutive stages. At the end of the test your VO2 max score will be displayed on the console. VO2 max stands for Volume of Oxygen uptake, which is a measurement of how much oxygen you need to perform a known amount of work.

The YMCA protocol uses two to four 3-minute stages of continuous exercise. On the test setup page, make sure to fix your physical parameters if they are not correct; this information will determine the results of your test.

Before the test,

- make sure you are in good health; check with your physician before performing any exercise if you are over the age of 35 or have any pre-existing health conditions;
- make sure you have warmed up and stretched before taking the test;
- do not take in caffeine before the test.

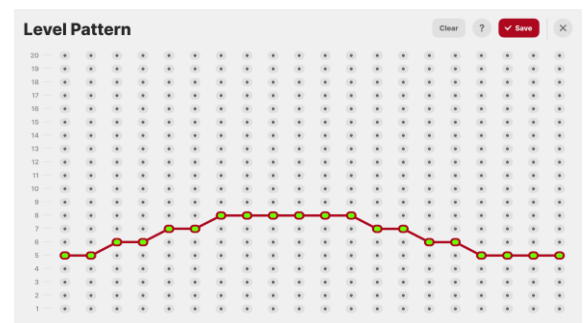
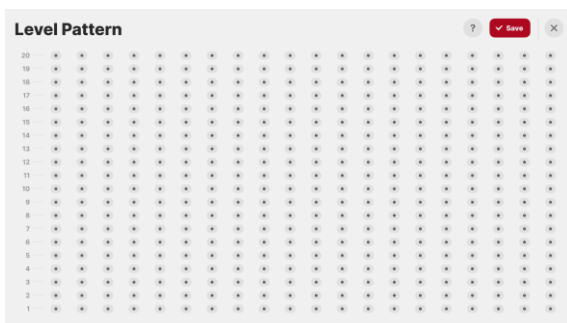

**Custom** is a program with fully customizable intensity patterns. On the program page, press “Add Pattern” to start editing. Connect dots to map your workload throughout the 20 segments of the program, from the easiest on the bottom to the hardest on the top. Created patterns can be edited later anytime. Each segment’s duration depends on the selected total time — you can set it right before start.

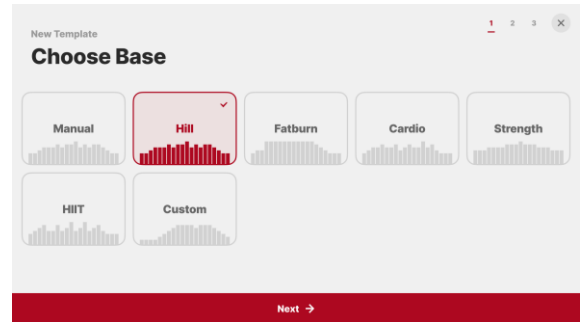
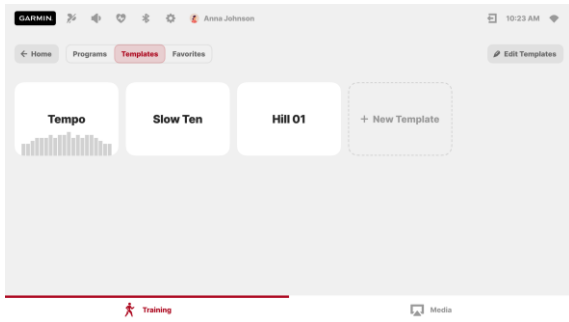

**Templates** are preset programs with a preserved set of parameters. Programs can be saved as templates upon completion, or you can create one from scratch in the Templates tab: tap on the “New Template” button, choose your base program, then save it with adjusted properties. A maximum of 12 template programs can be stored. To remove the unwanted templates, press “Edit Templates” in the Templates tab.

A program can be labeled as a **Favorite**. Up to 6 favorite programs will appear right on the Home screen, so you can access them easier. To “like” a program, open the program setup page and tap on the “ribbon” icon in the upper left corner of the screen. You can find all of the labeled programs under the Favorites tab: to remove the label, press “Edit Favorites”, or go to the program setup page directly and un-tap the “ribbon” icon.

Once you have decided on the program, press the “Start This Program” button on the screen, or the physical “START” key on the machine to begin your workout.

## History

To see your latest workout records, press “History” on the main screen of the Training section. Up to 10 records can be stored locally on the console, but you can access your full workout history if you link your profile to the SOLE+ mobile app. Tap on the record preview to see the full summary. Each user can only see his or her workouts.

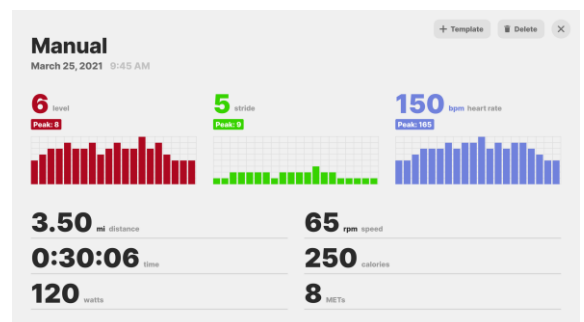
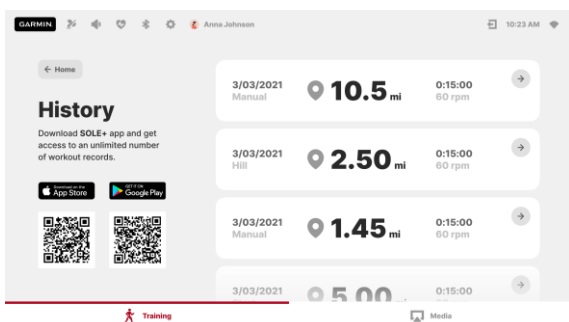

## Media

Tap on the right tab of the bottom panel to access the Media section. Choose from a variety of pre-installed third party **Apps**, or use the **Mirroring** function to cast the content from your smartphone directly to the console screen. For detailed instructions, press the ? icon.

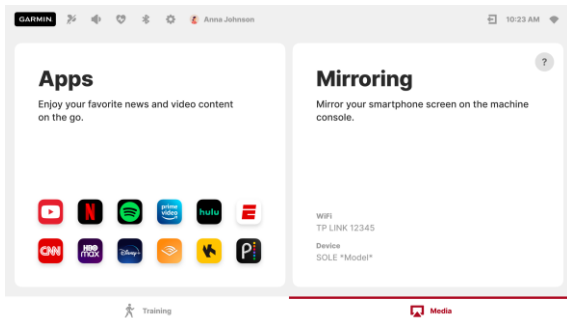

Once the content is on, use the floating panel for navigation and operating full screen mode. Touch the panel's top edge and drag the panel around the screen to find the perfect place for it, where it will not prevent you from interacting with the content. Press Hide Panels to enter the full screen mode without stats on the top and tabs on the bottom, and Show Panels to bring them back. Use the arrow button on the right side of the panel to hide & show the text labels: it allows to further minimize the panel's size. Press "Apps" to go back to the content sources selection.

## Workout Mode

Once the workout has been started, the console will appear in its workout mode. During the workout, switch between **Stats**, **Charts** and **Track** views of the Training section, or go to Media section to enjoy your favorite media content. In the Stats view, you can select parameters you would like to display by tapping on the number.

Please use physical keys to adjust level. Press the physical "STOP" key to pause the workout. Here, you can get back to training, start a cool down, or end your workout and see the summary. After 5 minutes of inactivity in the Pause mode, the workout will end automatically.

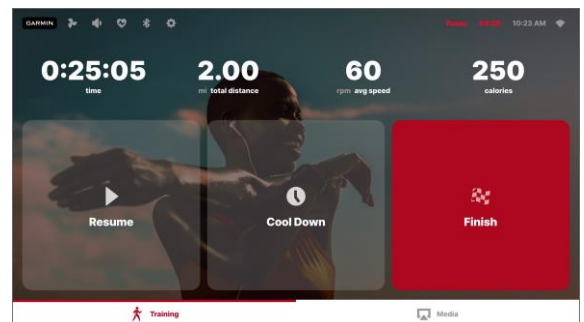
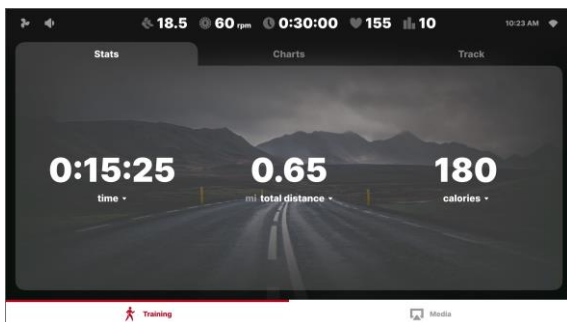

# HEART RATE PROGRAMS

## Before we get started, a word about Heart Rate:

The old motto, “no pain, no gain”, is a myth that has been overpowered by the benefits of exercising comfortably. A great deal of this success has been promoted by the use of heart rate monitors. With the proper use of a heart rate monitor, many people find that their usual choice of exercise intensity was either too high or too low and exercise is much more enjoyable by maintaining their heart rate in the desired benefit range.

To determine the benefit range in which you wish to train, you must first determine your Maximum Heart Rate. This can be accomplished by using the following formula: 220 minus your age. This will give you the Maximum Heart Rate (MHR) for someone of your age. To determine the effective heart rate range for specific goals you simply calculate a percentage your MHR. Your Heart rate training zone is 50% to 90% of your maximum heart rate. 60% of your MHR is the zone that burns fat while 80% is for strengthening the cardio vascular system. This 60% to 80% is the zone to stay in for maximum benefit.

For someone who is 40 years old their target heart rate zone is calculated:

$$220 - 40 = 180 \text{ (maximum heart rate)}$$

$$180 \times .6 = 108 \text{ beats per minute}$$

(60% of maximum)

$$180 \times .8 = 144 \text{ beats per minute}$$

(80% of maximum)

So for a 40 year old the training zone would be 108 to 144 beats per minute.

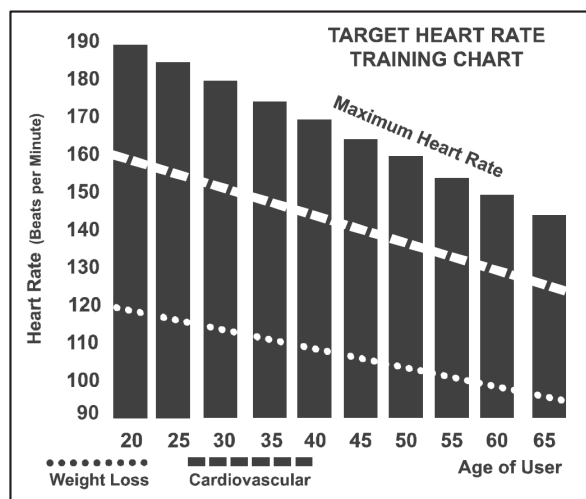

If you enter your age during programming the console will perform this calculation automatically. Entering your age is used for the Heart Rate control programs. After calculating your MHR you can decide upon which goal you would like to pursue.

The two most popular reasons for, or goals, of exercise are cardiovascular fitness (training for the heart and lungs) and weight control. The black columns on the chart above represent the MHR for a person whose age is listed at the bottom of each column. The training heart rate, for either cardiovascular fitness or weight loss, is represented by two different lines that cut diagonally through the chart. A definition of the lines' goal is in the bottom left-hand corner of the chart. If your goal is cardiovascular fitness or if it is weight loss, it can be achieved by training at 80% or 60%, respectively, of your MHR on a schedule approved by your physician. Consult your physician before participating in any exercise program.

With all SOLE Heart Rate Control fitness ELLIPTICAL machines you may use the heart rate monitor feature without using the Heart Rate Control program. This function can be used during manual mode or during any of the nine different programs. The Heart Rate Control program automatically controls resistance at the pedals.

## **RATE OF PERCEIVED EXERTION**

Heart rate is important but listening to your body also has a lot of advantages. There are more variables involved in how hard you should workout than just heart rate. Your stress level, physical health, emotional health, temperature, humidity, the time of day, the last time you ate and what you ate, all contribute to the intensity at which you should workout. If you listen to your body, it will tell you all of these things.

The rate of perceived exertion (RPE), also known as the Borg scale, was developed by Swedish physiologist G.A.V. Borg. This scale rates exercise intensity from 6 to 20 depending upon how you feel or the perception of your effort.

The scale is as follows:

Rating Perception of Effort

6 Minimal

7 Very,very light

8 Very,very light +

9 Very light

10 Very light +

11 Fairly light

12 Comfortable

13 Somewhat hard

14 Somewhat hard +

15 Hard

16 Hard +

17 Very hard

18 Very hard +

19 Very,very hard

20 Maximal

You can get an approximate heart rate level for each rating by simply adding a zero to each rating. For example a rating of 12 will result in an approximate heart rate of 120 beats per minute. Your RPE will vary depending up the factors discussed earlier. That is the major benefit of this type of training. If your body is strong and rested, you will feel strong and your pace will feel easier. When your body is in this condition, you are able to train harder and the RPE will support this. If you are feeling tired and sluggish, it is because your body needs a break. In this condition, your pace will feel harder. Again, this will show up in your RPE and you will train at the proper level for that day.

# USING HEART RATE TRANSMITTER (OPTIONAL)

If you purchase a wireless chest strap transmitter from Sole, here are the instructions on how to wear it:

1. Attach the transmitter to the elastic strap using the locking parts.
2. Adjust the strap as tightly as possible while ensuring that the strap is not too tight to remain comfortable.
3. Position the transmitter with the SOLE logo centered in the middle of your body, facing away from your chest. Some people may have to position the transmitter slightly left of the center of their chest. Attach the end of the elastic strap by inserting the round end. Using the locking parts, secure the transmitter and strap around your chest.
4. Position the transmitter immediately below the pectoral muscles.
5. Sweat is the best conductor for measuring minute heartbeat electrical signals. However, you can use plain water to pre-wet the electrodes. The electrodes are the two ribbed oval areas on the reverse side of the belt and both sides of the transmitter. We also recommend wearing the transmitter strap a few minutes before your workout to warm it up. Because of body chemistry, some users have a more difficult time achieving a strong, steady signal initially. Warming up with the transmitter will help decrease this problem. As noted, wearing clothing over the chest strap transmitter will not affect performance.
6. Your workout must be within range to achieve a strong and steady signal. The range length may vary, so stay close enough to the console to maintain strong and reliable readings. Wearing the transmitter immediately against bare skin assures you of proper operation. If you wish, you may wear the transmitter over a shirt. To do so, moisten the areas of the shirt where the electrodes will rest.

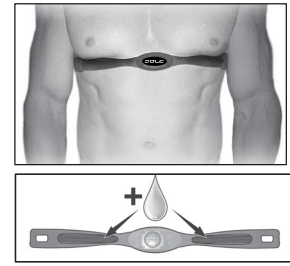

**Note:** The transmitter automatically activates when it detects activity from the user's heart and automatically deactivates when it does not receive any activity. Although the transmitter is water resistant, moisture can create false signals, so you should take precautions to dry the transmitter after use to prolong battery life completely. The estimated transmitter battery life is 2500 hours. The replacement battery is a Panasonic CR2032.

## ERRATIC OPERATION

**Caution!** Do not use this elliptical for Heart Rate unless a steady, solid Actual Heart Rate value is being displayed. High, wild, random numbers being displayed indicate a problem.

Areas to look for interference which may cause erratic heart rate:

1. Microwave ovens, TV's, small appliances, etc.
2. Fluorescent lights.
3. Some household security systems.
4. Perimeter fence for a pet.
5. Some people have problems with the transmitter picking up a signal from their skin. If you have problems try wearing the transmitter upside down. Normally the transmitter will be oriented so the SOLE logo is right side up.
6. The antenna that picks up your heart rate is very sensitive. If there is an outside noise source, turning the whole machine 90 degrees may de-tune the interference.
7. Another Individual wearing a transmitter within 3' of your machine's console.

If you continue to experience problems contact your dealer.

To check if your Garmin device can be used for heart rate transmission, please refer to the list of supported devices provided on [www.soletreadmills.com](http://www.soletreadmills.com)

# GENERAL MAINTENANCE

1. Wipe down all areas in the sweat path with a damp cloth after each workout.
2. If a squeak, thump, clicking or rough feeling develops the main cause is most likely one of two reasons:
  - I. The hardware was not sufficiently tightened during assembly. All bolts that were installed during assembly need to be tightened as much as possible. It may be necessary to use a larger wrench than the one provided if you cannot tighten the bolts sufficiently. I cannot stress this point enough; 90% of calls to the service department for noise issues can be traced to loose hardware or the rear rails being dirty.
  - II. Dirt build-up on the rear rails and polyurethane wheels are also a source of noise. Noise from build-up on the rails can cause a thumping sound that you would swear is coming from inside the main body of the machine because noise travels, and is amplified in the tubing of the frame. Clean the rails and wheels with a lint free cloth and rubbing alcohol. Stubborn build-up can be removed with your thumbnail or a non-metallic scraper, like the back edge of a plastic knife. After cleaning, apply a small amount of lubricant on the rails with your fingers or a lint free cloth. You only need a thin coat of lubrication, wipe off any excess.
3. If squeaks or other noises persist, check that the unit is properly leveled before calling the service department.

# MANUFACTURER'S LIMITED WARRANTY

## ELLIPTICAL WARRANTY

Effective February 1, 2023

SOLE warrants all its elliptical parts for a period of time listed below from the date of retail sale, as determined by sale receipt, or in the absence of a sales receipt eighteen (18) months from the original factory shipping date. SOLE's responsibilities include providing new or remanufactured parts, at SOLE's option, and technical support to our independent dealers and servicing organizations. In the absence of a dealer or service organization, these warranties will be administered by SOLE directly to a consumer. The warranty period applies to the following components:

Frame Weldments	Lifetime
Flywheel	Lifetime
All Other Components	3 Years
Labor	1 Years
Cosmetic Items*	90 Days

\*Cosmetic items including, but not limited to the following: grips, console overlays, and labels/decals.

### NORMAL RESPONSIBILITIES OF THE CONSUMER

This warranty applies only to products in ordinary household use, and the consumer is responsible for the items listed below:

1. The warranty registration card must be completed and returned to the address listed on the card within 10 days of the original purchase to validate the manufacturer's limited warranty or, if outside of the 10 day period, the warranty can be registered if you have proof of purchase (i.e. receipt, bank statement, credit card statement, or email order confirmation).
2. Proper use of the treadmill in accordance with the instructions provided in this manual, including general maintenance (i.e. belt tracking, belt tension, vacuuming under motor cover, and lubrication. See all components under General Maintenance section)
3. Proper installation in accordance with instructions provided with the elliptical and with all local electric codes.
4. Proper connection to a grounded power supply of sufficient voltage, replacement of blown fuses, repair of loose connections or defects in house wiring.
5. Expenses for making the elliptical accessible for servicing, including any item that was not part of the elliptical at the time it was shipped from the factory.
6. Damages to the elliptical finish during shipping, installation or following installation.
7. Routine maintenance of this unit as specified in this manual. (See All Components under General Maintenance).
8. Provide pictures or video of any issues via email as requested by the service technician. Assist with troubleshooting/diagnosing prior to a home visit

### EXCLUSIONS

This warranty does not cover the following:

1. CONSEQUENTIAL, COLLATERAL, OR INCIDENTAL DAMAGES SUCH AS PROPERTY DAMAGE AND INCIDENTAL EXPENSES RESULTING FROM ANY BREACH OF THIS WRITTEN OR ANY IMPLIED WARRANTY.  
**Note:** Some states do not allow the exclusion or limitation of incidental or consequential damages, so this limitation or exclusion may not apply to you.
2. Service call reimbursement to the consumer. Service call reimbursement to the dealer that does not involve malfunction or defects in workmanship or material, for units that are beyond the warranty period, for units that are beyond the service call reimbursement period, for elliptical not requiring component replacement, or elliptical not in ordinary household use.
3. Damages caused by services performed by persons other than authorized SOLE service companies; use of parts other than original SOLE parts; Or external causes such as corrosion (RUST), discoloration of paint or plastic, alterations, modifications, abuse, misuse, accident, improper maintenance-(see general maintenance instructions section), inadequate power supply, natural disasters, or elemental damage (i.e. power surges, lightning storms, water damage, or fire damage.)
4. Products with original serial numbers that have been removed or altered.
5. Products that have been: sold, transferred, bartered, or given to a third party. (Warranties DO NOT transfer.)
6. Products that do not have a warranty registration card on file at SOLE. SOLE reserves the right to request proof of purchase if no warranty record exists for the product.
7. THIS WARRANTY IS EXPRESSLY IN LIEU OF ALL OTHER WARRANTIES EXPRESSED OR IMPLIED, INCLUDING THE WARRANTIES OF MERCHANTABILITY AND/OR FITNESS FOR A PARTICULAR PURPOSE.
8. Product use in any environment other than a residential setting.
9. Warranties outside of North America may vary. Please contact your local dealer for details. Shipping charges may apply to Alaska and Hawaii customers.
10. Warranty will be void if the unit is not in a climate-controlled, insulated environment. (Examples: Garage, outside, carport, etc)

### SERVICE

Keep your bill of sale. Twelve (12) months from the date on the bill of sale or eighteen (18) months from the date of factory shipping as determined by the serial number establishes the labor warranty period should service be required. If service is performed, it is in your best interest to obtain and keep all receipts. This written warranty gives you specific legal rights. You may also have other rights that vary from state to state. Service under this warranty must be obtained by following these steps, in order:

1. Contact your selling authorized SOLE dealer. OR
2. Submit all service requests including serial number, contact information and a brief description of the problem online at <http://www.soletreadmills.com/serviceparts.html>.
3. If there is a question as to where to obtain service, contact our service department at 866-780-7653.
4. If no local service is available, SOLE will repair or replace the parts, at SOLE's option, within the warranty period at no charge for parts. All transportation costs, both to our factory and upon return to the owner, are the responsibility of the owner. The owner is responsible for adequate packaging upon return to SOLE. SOLE is not responsible for damages that occur during shipping. Make all freight damage claims with the appropriate freight carrier. DO NOT SHIP ANY UNIT TO OUR FACTORY WITHOUT A RETURN AUTHORIZATION NUMBER. All units arriving without a return authorization number will be refused.
5. The service department assists in troubleshooting prior to sending a field technician. SOLE may request pictures and video via email of issues to help with diagnosing.

**Before returning your Sole product to any retailer, or if you require any assistance with assembly or technical support please call us first for assistance at 866-780-7653. Thank you for your Sole purchase.**

**SOLE**  
FITNESS